

# Technical News Bulletin

Steinhausen, August 2015

---



## FPS Valve Tester and FPS Valve Repair

- The Valve Tester will enable customers to make simple repairs of dirty, or worn valves components, and test the performance of these valves before installation.
- The valve tester provides different functional test for FPS valves used for plunger up or counter blow/plunger cooling.
- An initial one cycle test validating the function of the valve and provides a go/no go result with the related error code.

## Introduction

Emhart Glass FPS technology has become a well accepted product to improve plunger operation, and parison formation. The equipment is standard on NIS Machines, and available as an option, or conversion, on IS and AIS machines.

Due to the increased adaptation of this technology, and to continue to focus of products to improve maintenance and reduce customer operating costs, an FPS Valve Tester has been added to the product portfolio. Combined with basic repair kits for the FPS Valves, the Valve Tester will enable customers to make simple repairs of dirty, or worn valves components, and test the performance of these valves before installing them on their IS, AIS, or NIS machines.

## Features of the Valve Tester

All functions of the FPS valves will be tested according to the type of the valve and according to the application. The valve tester provides different functional test for FPS valves used for plunger up or counter blow/plunger cooling.

Three different test modes are possible:

An initial one cycle test validating the function of the valve and provides a go/no go result with the related error code.

A 1000 cycle test provides the possibility to detect multiple error sources which may occur randomly. The errors are counted during this 1000 cycles and the error code is displayed together with the number of errors.

A third “endless test”, which stops after the first error, which will also be displayed. This test is normally used to verify the performance of a valve after a valve repair.

The following errors can be detected:

- Pressure rise time range
- Pressure fall time range
- Pressure output range
- Pressure output oscillation range
- Leakage supply cartridge
- Leakage exhaust cartridge
- Electronic error

The following valves are supported by the valves tester:

- ND07 spade terminal (59-90272)
- ND07 Harting connector (SE-12552-1)
- ED07 M12 connector (59-90311)
- ED07 M12 connector (59-27249)
- ED07 M12 connector NIS (59-27229)
- ND12 spade terminal (59-90281)
- ND12 Harting connector (SE-12552-2)
- ED12 M12 connector (59-90319)
- ED12 M12 connector NIS (59-27230)
- ED19 ISO interface (59-27262-1)
- ED19 Ross 21 interface (59-27262-2)

## Specification of the valve tester

### Media supply:

Power Supply:	93-264V 47-63Hz
Supply pressure:	>4.5 bar < 10 bar
Temperature	10°-50°C

### Air requirements:

Compressed air purity class	DIN ISO 8573-1
Solid impurities:	ISO class 4
Water content:	ISO class 4
Oil content:	ISO class 4

### Parts included (59-90316):

- Valve tester
- Power cable
- Adapter plate for ND/ED07
- Adapter plate for ND/ED12
- Connection cable M12 connector – spade terminals (59-90401)
- Connection cable Harting connector – spade terminals (SE-12553-03)
- Self testing device

**Parts optional:**

- Adapter plate for ED19 ISO-interface  
59-27402
- Adapter plate for ED19 Ross 21 interface  
59-27403



Top left: ND12  
Bottom right: ED07

**Repair kit components**

The valve seats of the proportional valves are subject of wear due to the possible contamination of the valves with residues of swabbing material, oil and even glass particles.

Poorly performing valves are tested with the valve tester to detect the reason for the malfunction. In most cases, faulty operation is caused by leakage of the supply and exhaust cartridges. The leakage of the supply and exhaust cartridge can be eliminated in most cases with the exchange of the valve seats.

This is possible with the help of the fixture. Only the valve seat itself will be exchanged during this procedure. All the other parts in the cartridge remain. The cartridge is mechanically calibrated with shims which contribute to the high precision of the FPS valves. It is important that all the other parts in the cartridge remain unchanged. During the disassembly and the assembly of the valve attention has to be paid to separate the supply and the exhaust cartridge. The two cartridges are different from each other. The supply and exhaust cartridge has to stay in the same valve body as both cartridges are electronically calibrated which is an important factor for the precision and speed of the valve. It is recommended to exchange the O-rings of the cartridge during the repair as well.

After the repair it is required to test the valve again with the valve test to validate if the repair was successful. This procedure offers a cost effective method to increase the lifetime of the valves and keep the high performance levels.

**Part Numbers:**

- Valves Tester 59-90316
- Fixture for cartridge 94-5261

**ED12**

- Valve Seat for ED12 59-27258  
(30 pieces per package)
- O-Ring for ED12 cartridge 1700-986 (2x)
- O-Ring for ED12 cartridge 1700-1111
- Lip Seal 59-27565
- O-Ring for Lip Seal 1700-1252
  
- Base seal and mounting screws ED12/ND12 3340-1593

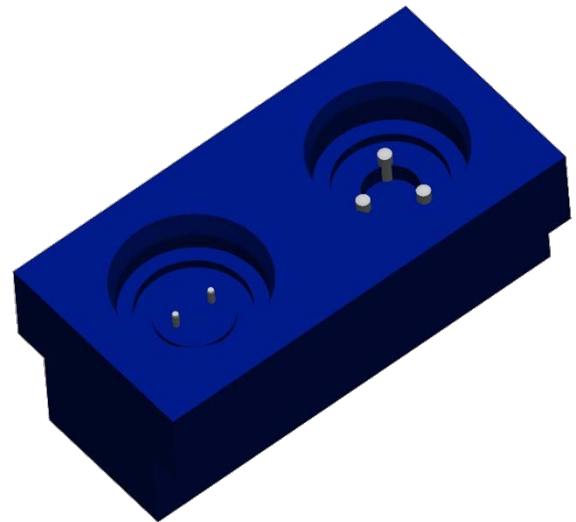

Fixture for Cartridge

**ND12**

- Valve Seat for ND12 59-27261  
(30 pieces per package)
- O-Ring for ND12 cartridge 1700-1223
- O-Ring for ND12 cartridge 1700-1111
- O-Ring for ND12 cartridge 1700-804
- Lip Seal 59-27565
- O-Ring for Lip Seal 1700-1252
  
- Base seal and mounting screws ED12/ND12 3340-1593

**ED07/ND07**

- Valve Seat for ED07/ND07 59-27257  
(30 pieces per package)
- O-Ring for ED07/ND07 cartridge 1700-986
- O-Ring for ED07/ND07 cartridge 1700-358
- O-Ring for ED07/ND07 cartridge 1700-683
- Lip Seal 59-27564
- O-Ring for Lip Seal 1700-656
  
- Base seal and mounting screws

- ED07 3340-1633
- Base seal and mounting screws
- ND07 3340-1592

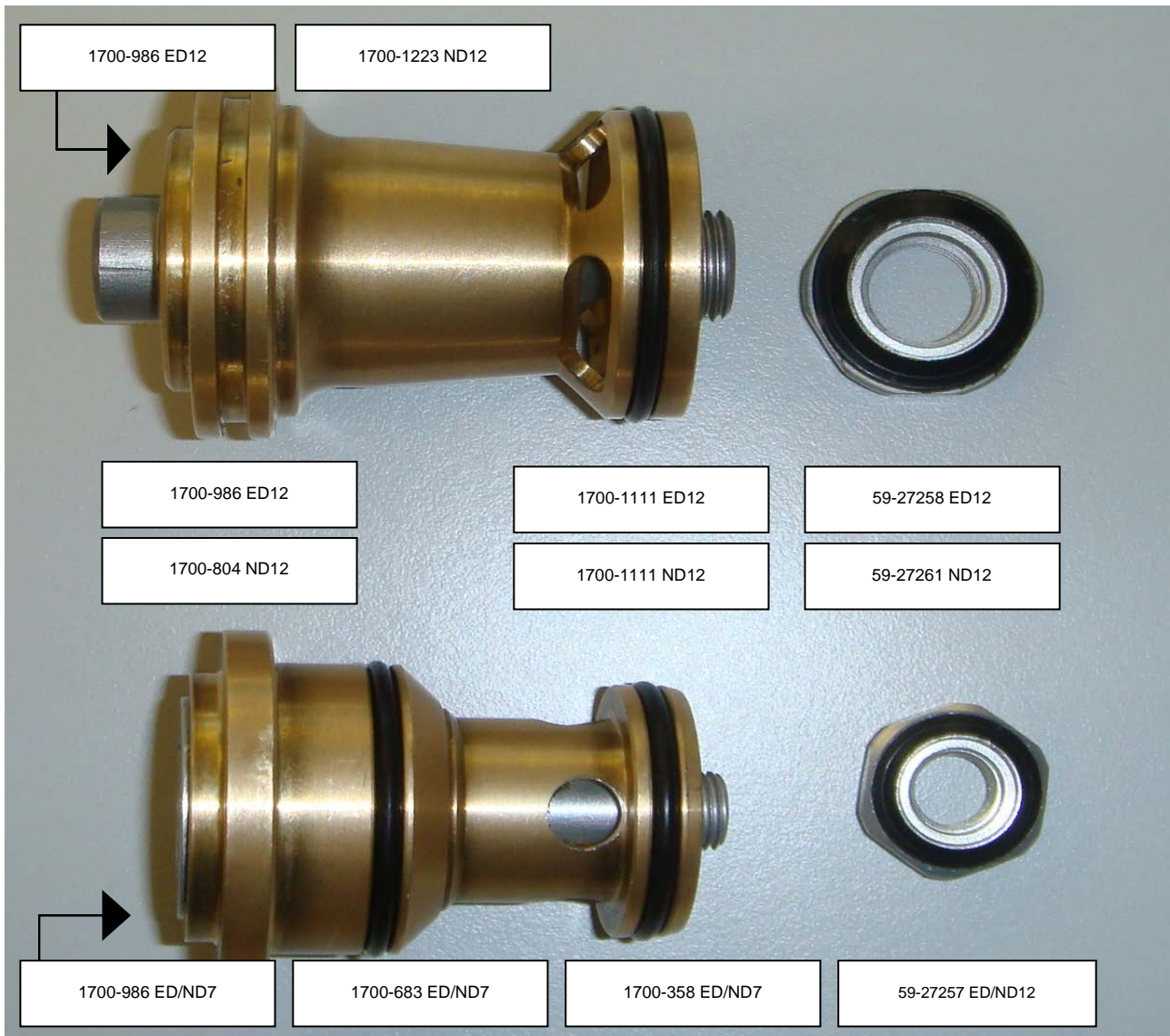

Top: ED12 cartridge and valve seat  
Bottom: ED07 cartridge and valve seat



**Exhaust cartridge ED07 (E ED07)**

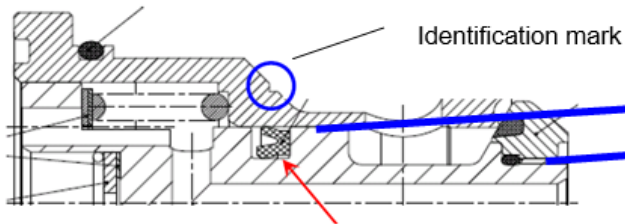

Lip Seal	59-27564
O-Ring	1700-656

**Supply cartridge ED07 (S ED07)**

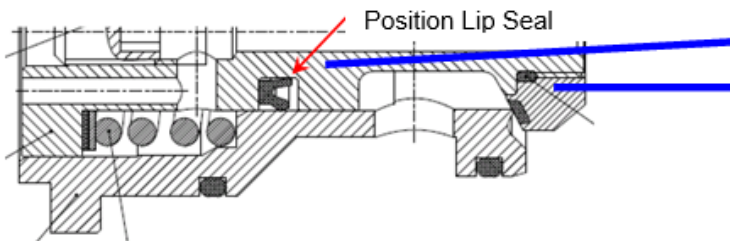

Lip Seal	59-27564
O-Ring	1700-656

**Exhaust cartridge ED12 (E ED12)**

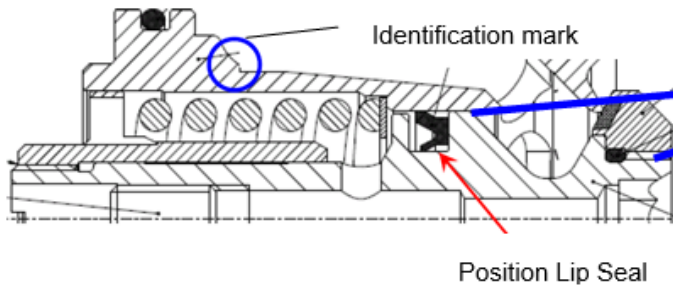

Lip Seal	59-27565
O-Ring	1700-1252

**Supply cartridge ED12 (E ED12)**

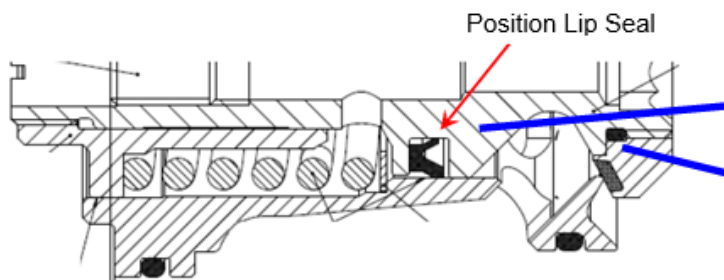





Lip Seal	59-27565
O-Ring	1700-1252

**Grease for Sealing**

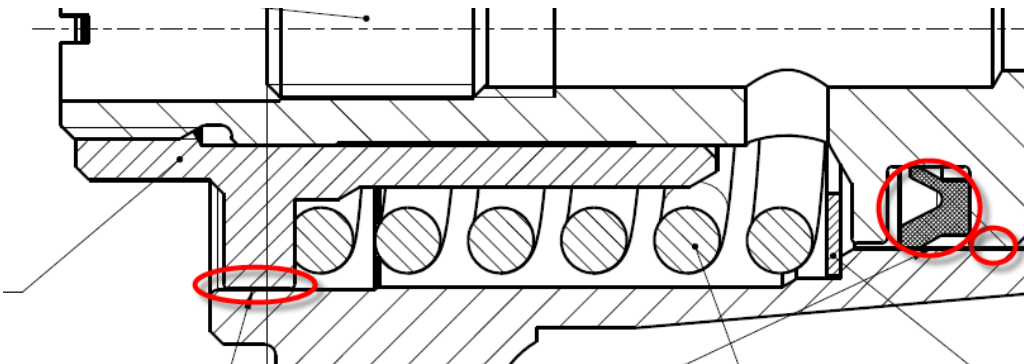
Tube 20 g, 59-27568

Thickness of grease film approx. 0,2 mm



Error code	Meaning	Remedy	Area of Attention
0	No error detected	--	
1	Rise time out of range	Check supply cartridge. Exchange sealing, if necessary.	S ED07 or S ED12 
2	Fall time out of range	Check exhaust cartridge. Exchange sealing, if necessary.	E ED07 or E ED12 
3	Output pressure out of range	Valve requires repair through Emhart Glass	--
4	Oscillation output pressure out of range	Check supply and exhaust cartridge. Exchange sealing, if necessary.	S ED07 / E ED07 or S ED12 / E ED12 
5	Feedback signal out of range (if feedback test is activated)	Valve requires repair through Emhart Glass (if feedback signal is required, if not error can be ignored)	--
6	Oscillation feedback signal out of range (if feedback test is activated)	Check supply and exhaust cartridge. Exchange sealing, if necessary.	S ED07 / E ED07 or S ED12 / E ED12 

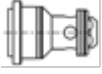
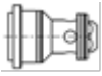

7	Leakage supply cartridge (it could be possible that additionally the exhaust cartridge has a small leakage.	Check supply cartridge. Exchange sealing, if necessary.	S ED07 or S ED12 
8	Leakage exhaust cartridge (it could be possible that additionally the exhaust cartridge has a small leakage.	Check exhaust cartridge. Exchange sealing, if necessary.	E ED07 or E ED12 

Error code	Meaning	Remedy	Area of Attention
9	Supply pressure for short or long periods of time too low.	Check supply pressure for tester and tube cross section of supply tube. Increase supply pressure, if necessary.	--
10	Invalid program selection. Program does not exist.	Check if the correct test programme (Switch A to C) in combination with the tested valve. See possible combinations listed in operation manual. Choose the correct test programme.	--
11	Malfunction of the electronics. The error code is shown in the 4th line of the display „EE: 11“ (Electronic Error). *	Valve requires repair through Emhart Glass * Only in combination with error 3 and 5	--

## Valves repair through exchange pool

In addition to the exchange for the valve seat, the possibility of the entire exchange of the valve body including cartridges, coils and sealing is offered by Emhart Glass.

This mechanical overhaul of the valve will also include a complete new calibration of the valve to achieve the same performance and speed as a new one, and can only be carried out by the manufacturer of the valve.

Emhart Glass holds a pool of these valves to guarantee quick availability. This repair will be available for the following valves:

New Part Number	Repair Part Number
<b>ED 07</b>	
59-90311	59-90311-RS
59-27249	59-27249-RS
59-27229	59-27229-RS
<b>ED 12</b>	
59-90319	59-90319-RS
59-27230	59-27230-RS
<b>ED 19 FPS Part</b>	
59-27277	59-27277-RS



Valves older than 4 years will not be accepted for repair. The manufacturing date can be read for the serial number (SN). The first two digits give the year and next two digits giving the manufacturing month. The valve shown in the picture was produced in September 2007 (07-09XXX).