

Technical News Bulletin

August, 2016

VertiFlow Assist for NIS machines

Introduction

Additional cooling in the form of “VertiFlow Assist” is now a reality with the introduction of a new mold cooling solution at the Blow side on the NIS machine. The new cooling system, which requires new Blow molds, can be used in addition of the standard Blow mold holder equipment, and is available for all new NIS machines equipped with the mold side cooling air supply. The ‘VertiFlow Assist’ is taking cooling air from the main cooling air supply via cooling wind valves to newly designed Blow side plenum chambers; the cooling wind is then conducted to the mold via vertical holes, cooling down the mold in the “bottom-up” direction. The VertiFlow Assist is to be used in conjunction with one row of standard VertiFlow cooling holes, for maximum cooling efficiency.

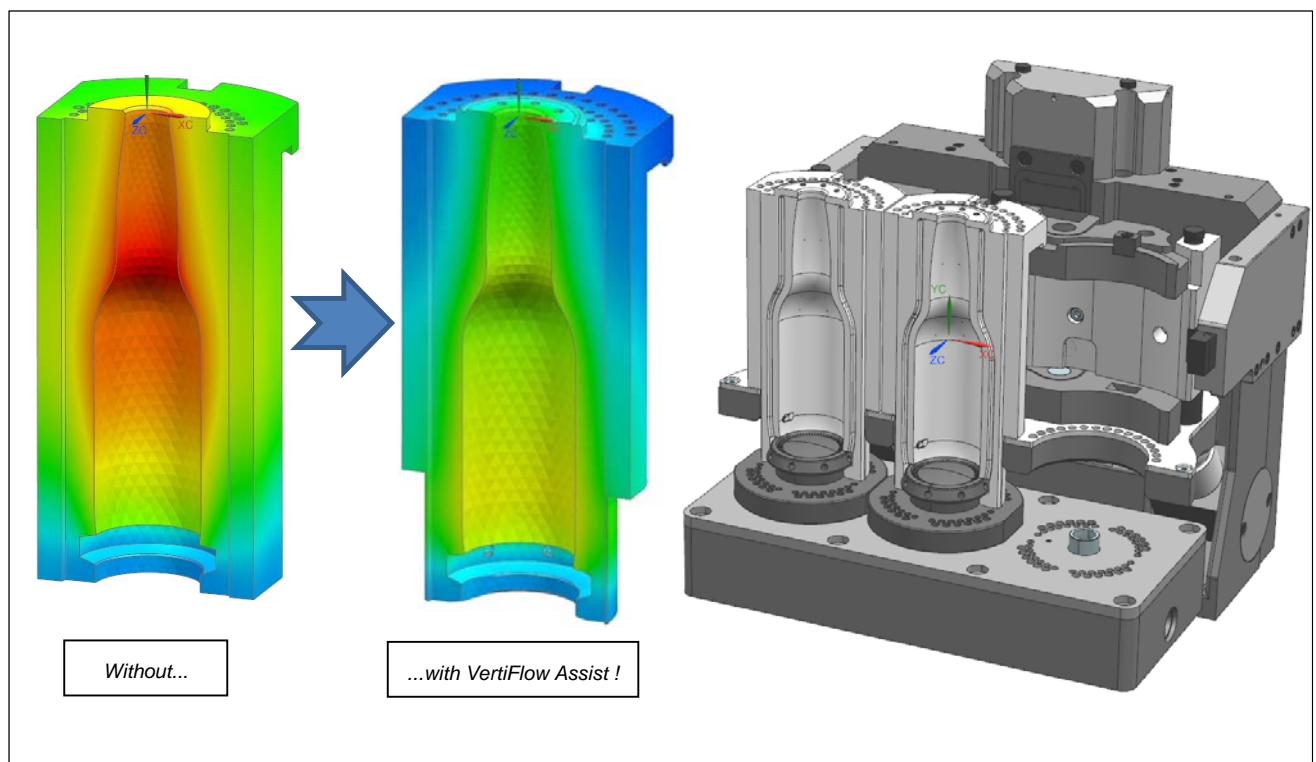

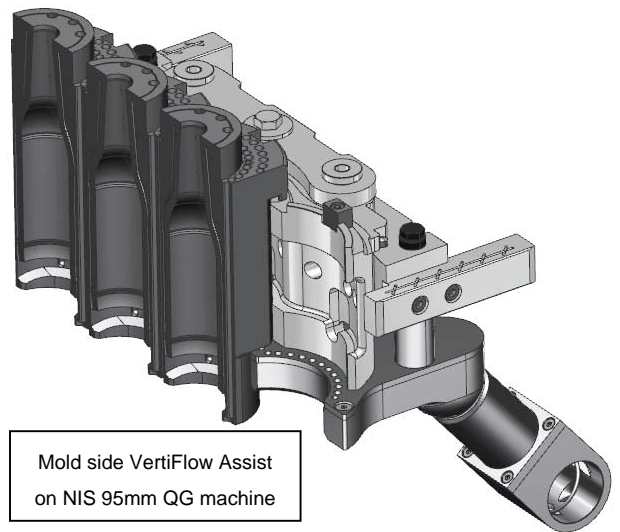
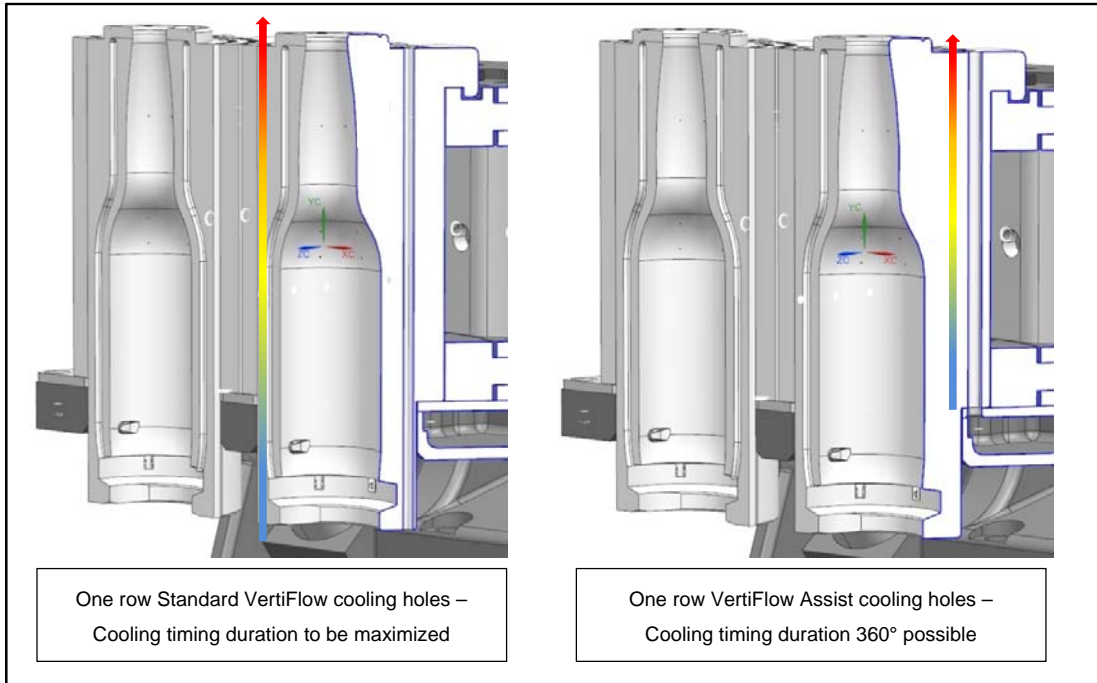

When only using standard VertiFlow through the bottom plate mechanism at higher cavity rates, the Blow mold cooling might reach its limit, so that mold temperatures above 500°C are achieved, usually located in the body/shoulder area of the mold cavity, reducing consequently production speeds and affecting containers' quality. This can become a drawback for NNP&B containers, due to reduced cooling timing duration of the standard VertiFlow: cooling air is available, but for a restricted time, resulting in high Blow mold temperatures, which affects accordingly the containers' quality (leaners).

Bucher Emhart Glass now introduces the VertiFlow Assist on NIS machines. This additional cooling supplied via a plenum chamber on an outer row of vertical cooling holes is to be used in conjunction with one row of vertical holes from the standard VertiFlow cooling through the Bottom plate mechanism, located on a different Pitch Circle Diameter (PCD): VertiFlow Assist does NOT replace the standard VertiFlow cooling.

Thanks to VertiFlow Assist, not only we are able to decrease significantly Blow mold temperatures, but we have the unique capability to influence and balance "vertically" the temperatures on the Blow mold cavity: indeed, standard VertiFlow and VertiFlow Assist can be actuated independently, so that this dual cooling makes it possible for the operator to achieve the right temperature gradient on the Blow mold cavity, to ensure the ideal container quality at higher speeds. Usually, the cooling duration for standard VertiFlow is to be maximized, as the standard VertiFlow cooling holes are "closer" to the mold cavity (closer to glass), allowing a higher heat removal from glass; the cooling duration of the VertiFlow Assist is defined in a way to achieve the right targeted temperature range, not too hot, and not too cold. By principle, it is possible to keep the VertiFlow Assist cooling channel ON for 360°, allowing a decrease of the temperatures gradient [min-max] in the mold, increasing consequently mold lifetime (less stress in the mold material).

Specification

The system components are listed on assembly drawing 400-5199: it should be noted that the NIS VertiFlow Assist equipment can be mounted on standard NIS mold holder assemblies, so that all existing NIS carriers and mold holder plates can be reused.

It is not possible to re-use existing Blow molds when upgrading to VertiFlow Assist, as a VertiFlow Assist Blow mold requires the second row of cooling holes to be aligned on the PCD defined by the plenum chamber.

Accessories and variables

The accessories are defined on drawing 400-5199-00: an extract is shown below, for DG, TG and QG operations, based on the various standard mold design setup assemblies available on the NIS machine:

VertiFlow Assist Reference setups - NIS 5" TG			
VertiFlow Assist reference	400-5199-6	400-5199-7	400-5199-8
Band diameter	6"	6"	6"
Plenum chamber PCD	138mm		
Standard setup reference (w/o VertiFlow Assist)	Double Deck		
	Short Carrier	Tall Carrier	Extra Tall Carrier
Part number	400-5163-2	400-5163-3	400-5163-4
DataSheet	NIS-500-3-161	NIS-500-3-162	NIS-500-3-163
"H" dim	"H" = 10mm	"H" = 40mm	"H" = 40mm
"S" dim	"S" = 85mm	"S" = 130mm	"S" = 160mm

VertiFlow Assist Reference setups - NIS 6 1/4" DG			
VertiFlow Assist reference	400-5199-9	400-5199-10	400-5199-11
Band diameter	6 5/8"	6 5/8"	6 5/8"
Plenum chamber PCD	156mm		
Standard setup reference (w/o VertiFlow Assist)	Double Deck		
	Short Carrier	Tall Carrier	Extra Tall Carrier
Part number	400-5173-1	400-5173-2	400-5173-4
DataSheet	NIS-625-2-161	NIS-625-2-162	NIS-625-2-163
"H" dim	"H" = 10mm	"H" = 40mm	"H" = 40mm
"S" dim	"S" = 85mm	"S" = 130mm	"S" = 160mm

VertiFlow Assist Reference setups - NIS 95mm QG		
VertiFlow Assist reference	400-5199-5	400-5199-12
Band diameter	4 5/8"	4 5/8"
Plenum chamber PCD	107.5mm	
Standard setup reference (w/o VertiFlow Assist)	Insert type	
Part number	400-5116-2	400-5116-3
DataSheet	NIS-095-4-151	NIS-095-4-152
"H" dim	"H" = 15mm	"H" = 35mm
"S" dim	"S" = 102.5mm	"S" = 97.5mm

Mold Design considerations and principles:

Existing NIS TG-DG-QG Blow molds can not be reused in conjunction with VertiFlow Assist. Therefore, new Blow molds are required, whereby the cooling holes pattern must be defined carefully, according to the principles defined in the mold design book.

1) NIS TG:

VertiFlow Assist Reference setups			
VertiFlow Assist reference	400-5199-6	400-5199-7	400-5199-8
Min Mold length under Invert Centerline	140	155	185
Nominal "J" dim - Setup	115.3	160.3	190.3
Nominal "J" dim - Mold (to be achieved in hot conditions)	115	160	190
"J" dim with typical thermal expansion allowance: "J" dim 0 -0.2			
Cast Iron	114.4	159.2	189
Bronze	114.1	158.8	188.6

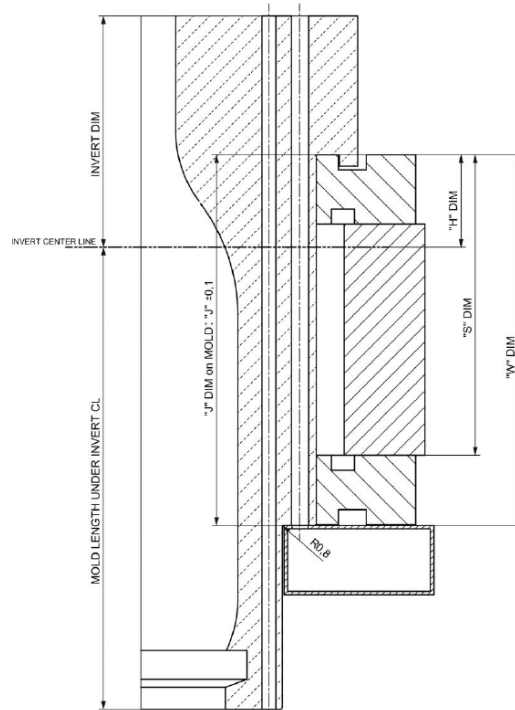
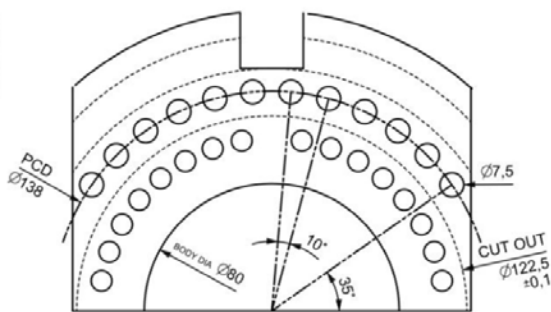
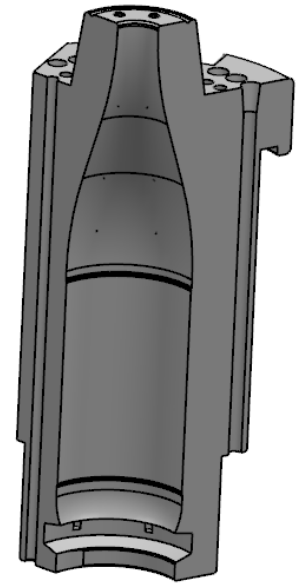

2) **NIS DG:**

VertiFlow Assist Reference setups			
VertiFlow Assist reference	400-5199-9	400-5199-10	400-5199-11
Min Mold length under Invert Centerline	140	155	185
Nominal "J" dim - Setup	115.3	160.3	190.3
Nominal "J" dim - Mold (to be achieved in hot conditions)	115	160	190
"J" dim with typical thermal expansion allowance: "J" dim 0 -0.2			
Cast Iron	114.4	159.2	189
Bronze	114.1	158.8	188.6

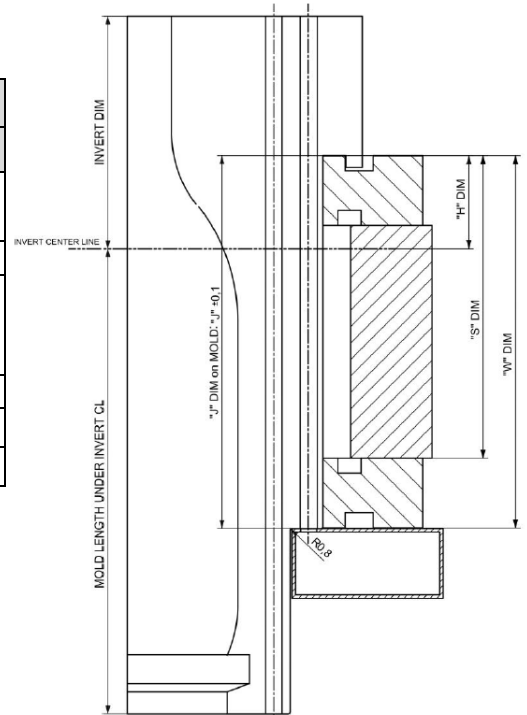
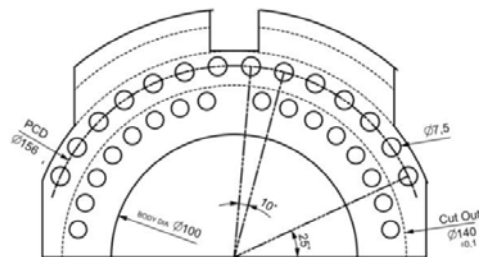

3) **NIS QG:**

VertiFlow Assist Reference setups		
VertiFlow Assist reference	400-5199-5	400-5199-12
Min Mold length under Invert Centerline	140	120
Nominal "J" dim - Setup	122	122
Nominal "J" dim - Mold (to be achieved in hot conditions)	121.5	121.5
"J" dim with typical thermal expansion allowance: "J" dim 0 -0.2		
Cast Iron	120.9	120.9
Bronze	120.6	120.6

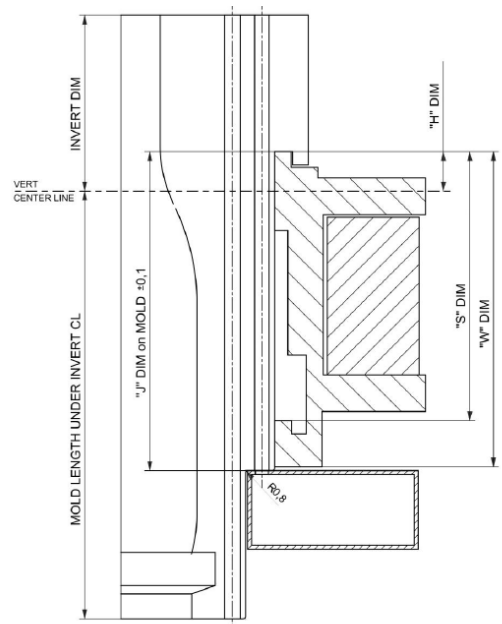
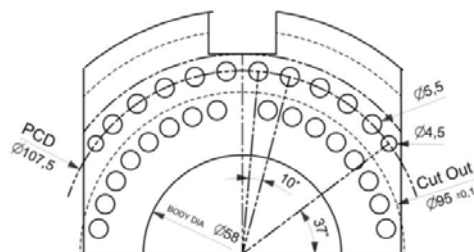

Test case analysis: Theory versus Practice:

To validate the VertiFlow Assist cooling, FEM mold cooling simulations as well as trials under real conditions have been performed. The thermal models below are all set to the same scale, and show the expected theoretical temperatures for:

- Cast iron Blow mold with standard Vertiflow.
- Cast iron Blow mold combined with both standard VertiFlow and VertiFlow Assist.

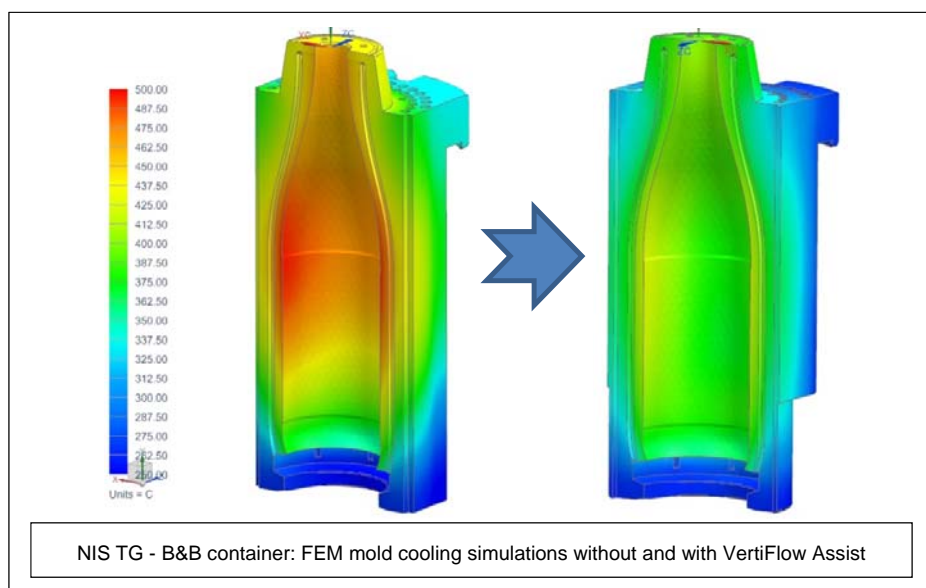
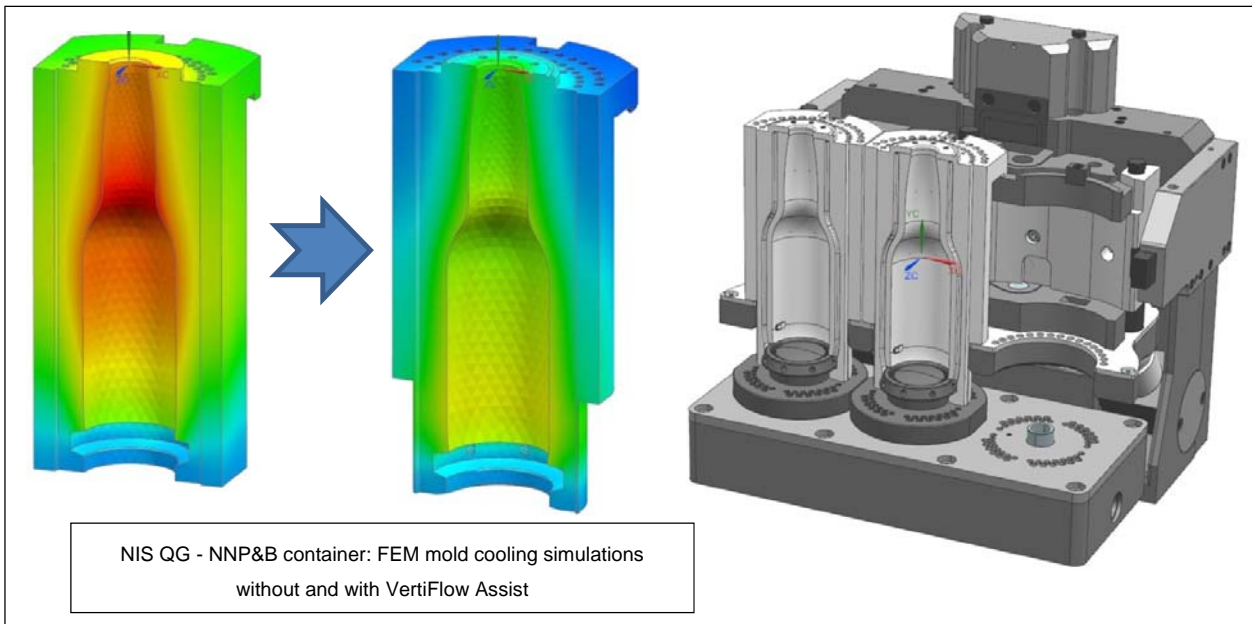

Availability / Application

Only available for new supplied NIS machines

The VertiFlow Assist cooling is available on NIS for all newly supplied NIS machines, where the necessary cooling air supply system is assembled. For older NIS machines, this mold side air supply does not exist, and therefore, those machine can not be upgraded to VertiFlow Assist.

Features / Benefits

Increased cooling capacity	Potential for speed increase / a MUST for NNP&B process
Additional control of vertical temperature profile	Improved Quality of containers
Reduced thermal cycling of mold	Potential increase in mold lifetime